



# 2N<sup>®</sup> Analog Vario

## Door Access Intercom



## Installation Manual

**Version:** 1.5

[www.2n.cz](http://www.2n.cz)

The 2N TELEKOMUNIKACE a.s. is a Czech manufacturer and supplier of telecommunications equipment.



The product family developed by 2N TELEKOMUNIKACE a.s. includes GSM gateways, private branch exchanges (PBX), and door and lift communicators. 2N TELEKOMUNIKACE a.s. has been ranked among the Czech top companies for years and represented a symbol of stability and prosperity on the telecommunications market for almost two decades. At present, we export our products into over 120 countries worldwide and have exclusive distributors on all continents.



2N<sup>®</sup> is a registered trademark of 2N TELEKOMUNIKACE a.s. Any product and/or other names mentioned herein are registered trademarks and/or trademarks or brands protected by law.



2N TELEKOMUNIKACE a.s. administers the FAQ database to help you quickly find information and to answer your questions about 2N products and services. On [www.faq.2n.cz](http://www.faq.2n.cz) you can find information regarding products adjustment and instructions for optimum use and procedures „What to do if...“.



2N TELEKOMUNIKACE a.s. hereby declares that the 2N product complies with all basic requirements and other relevant provisions of the 1999/5/EC directive. For the full wording of the Declaration of Conformity see the CD-ROM (if enclosed) or our website at [www.2n.cz](http://www.2n.cz).



The 2N TELEKOMUNIKACE a.s. is the holder of the ISO 9001:2009 certificate. All development, production and distribution processes of the company are managed by this standard and guarantee a high quality, technical level and professional aspect of all our products.

---

# Content:

---

- 1. Product Overview
  - 1.1 Components and Associated Products
  - 1.2 Terms and Symbols Used
- 2. Description and Installation
  - 2.1 Before You Start
  - 2.2 Mechanical Installation
  - 2.3 Electrical Installation
  - 2.4 Camera Installation
  - 2.5 Extending Module Connection
  - 2.6 Buttons Labels - Insertion, Replacement
  - 2.7 Mounting - Completion
- 3. Function and use
  - 3.1 Programming
  - 3.2 Full Parameter Chart
  - 3.3 Function Description
  - 3.4 Section for Advanced Users
  - 3.5 Maintenance
  - 3.6 Downloads
- 4. Technical Parameters
  - 4.1 Obecné výkresy
- 5. Supplementary Information
  - 5.1 Troubleshooting
  - 5.2 Directives, Laws and Regulations
  - 5.3 General Instructions and Cautions

---

# 1. Product Overview

---

In this section, we introduce the **2N<sup>®</sup> Analog Vario** product, outline its application options and highlight the advantages following from its use.

Here is what you can find in this section:

- **1.1 Components and Associated Products**
- **1.2 Terms and Symbols Used**

The **2N<sup>®</sup> Analog Vario** door communicator replaces a traditional door entry system which would traditionally have to have a whole cabled distribution infrastructure behind it. The connectivity of the unit is flexible in that as standard the unit can connect to any telephone system via either an analogue extension or trunk port. The **2N<sup>®</sup> Analog Vario** can also connect to any network provider's analogue telephone line.

**2N<sup>®</sup> Analog Vario** is also easy to use. Just press the desired call button and **2N<sup>®</sup> Analog Vario** will automatically 'dial' the number pre-stored in the respective memory. The number of buttons is flexible as it is a modular unit.

**2N<sup>®</sup> Analog Vario** also has a switch that controls the electric lock by using any telephones keypad (by tone-dialling the password).

In addition to the buttons, you can use a numerical keypad, which is used as a code lock. Using the keypad, you can operate the device as a button telephone and dial the required numbers directly or retrieve them from any of the 54 memories available. You can disable non-desired functions.

**2N<sup>®</sup> Analog Vario** provides improved and feature rich options compared with standard door entry systems, this is because you can make use of functions such as call redirection if not answered, or have a day and night mode set up for automatic redirection of the call for instance after normal working hours.

---

The 2N<sup>®</sup> Analog Vario parameters meet all technical requirements mandatory for devices designed for the PSTN (public switched telephone network) connection.

### Basic Features

- Exclusive design – high-grade stainless steel finish.
- Water resistant
- Exclusive white button backlight – white LEDs
- Modularity – up to 54 buttons + keypad
- Up to 16 buttons per unit
- Each basic unit has a space for camera and card reader build-in modules
- Increased protection through optional Vandal Resistant panel.
- Telephone-controlled electronic lock switch
- Detection of all standard tones - hangs up automatically
- Easy, voice menu based remote programming via telephone.
- Applicable as a standard telephone and code lock (keypad version)

### Advantages of Use

- Flat design – installation no need to cut into mounting surface
- Hermetically sealed, solid state buttons
- Electronics is separated from name plates
- Electronic volume and Hands-Free control – no need to open cover
- Operates on any analogue telephone line
- Stable line power feeding
- High acoustic quality
- Special functions includes automatic dialling of multiple numbers, silent dialling, departure/arrival, day/night mode, second switch delay

# 1.1 Components and Associated Products

## Basic and Extender Units

Part No. 9135110E







- Basic unit
- 1 button

Part No. 9135130E









- Basic unit
- 3 buttons

<p><b>Part No. 9135160E</b></p> 	<ul style="list-style-type: none"> <li>• Basic unit</li> <li>• 3 × 2 buttons</li> </ul>
<p><b>Part No. 9135110KE</b></p> 	<ul style="list-style-type: none"> <li>• Basic unit</li> <li>• 1 button + keypad</li> </ul>

<p><b>Part No. 9135130KE</b></p> 	<ul style="list-style-type: none"> <li>• Basic unit</li> <li>• 3 buttons + keypad</li> </ul>
<p><b>Part No. 9135160KE</b></p> 	<ul style="list-style-type: none"> <li>• Basic unit</li> <li>• 3 × 2 buttons + keypad</li> </ul>



<p><b>Part No. 9135310E</b></p> 	<ul style="list-style-type: none"> <li>● Info panel</li> <li>● backlit button-less panel</li> <li>● used for the telephone directory, house number, etc.</li> </ul>
<p><b>Part No. 9135181E</b></p> 	<ul style="list-style-type: none"> <li>● Extender unit</li> <li>● 8 buttons</li> </ul>

<p><b>Part No. 913582E</b></p> 	<ul style="list-style-type: none"> <li>• Extender unit</li> <li>• 8 × 2 buttons</li> </ul>
<p><b>Part No. 9135311E</b></p> 	<ul style="list-style-type: none"> <li>• Info panel - name plate</li> <li>• Replaces four name plates with one cover.</li> <li>• Enables the use of one half of the extender unit for the telephone directory, opening hours, etc.</li> </ul>
<p><b>Part No. 9135301E</b></p> 	<ul style="list-style-type: none"> <li>• Spare button name plate</li> </ul>
<p><b>Part No. 9135302E</b></p> 	<ul style="list-style-type: none"> <li>• Spare double-button name plate</li> </ul>

All the above-mentioned units can be wall mounted without requiring any additional accessories. All the basic units can be complemented with a camera, proximity reader (see later) and display (under preparation). All units can be made more resistant using the Vandal resistant cover. Additional accessories (see later) are needed for outdoor flush mounting purposes.

## Installation Accessories

Part No. 9135331E



- Surface 1-module roof
- **Dimensions:** (103 × 218 × 60) mm (W × H × D)

Part No. 9135351E





- Wall mounting box with 1-module frame
- **Dimensions:** (125 × 235 × 46) mm (W × H × D)
- **Wall hole:** (110 × 220 × 50) ±5 mm

Part No. 9135361E



- Wall mounting box with 1-module roof
- **Roof dimensions:** (129 × 240 × 41) mm (W × H × D)
- **Wall hole:** (110 × 220 × 50) ±5 mm

<p><b>Part No. 9135332E</b></p> 	<ul style="list-style-type: none"> <li>• Surface 2-module roof</li> <li>• <b>Dimensions:</b> (203 × 218 × 60) mm (W × H × D)</li> </ul>
<p><b>Part No. 9135352E</b></p> 	<ul style="list-style-type: none"> <li>• Wall mounting box with 2-module frame</li> <li>• <b>Dimensions:</b> (225 × 235 × 46) mm (W × H × D)</li> <li>• <b>Wall hole:</b> (210 × 220 × 50) ±5 mm</li> </ul>
<p><b>Part No. 9135362E</b></p> 	<ul style="list-style-type: none"> <li>• Wall mounting box with 2-module roof</li> <li>• <b>Roof dimensions:</b> (229 × 240 × 41) mm (W × H × D)</li> <li>• <b>Wall hole:</b> (210 × 220 × 50) ±5 mm</li> </ul>

The mounting accessories are made of "marine grade" stainless steel. For outdoor applications, the use of the roof is required unless weather protection is provided otherwise. The box with frame (without roof) allows for installation of **2N<sup>®</sup> Analog Vario** in indoor applications so that the unit does not practically stick out (up to 1 mm).

## GSM and VOIP Connection Accessories

Part No. 501333E



2N<sup>®</sup> EasyGate PRO - GSM gateway

## Video Accessories

Part No. 9135200E







- In-built colour CCD camera
- PAL, resolution 420 TV rows, sensitivity 2 lux.
- Camera can be built in any basic unit. In the case of poor light, the camera switches into the monochrome mode automatically. Supplementary infrared light. Horizontal/vertical tilting option.

## Electric Locks

<p>Part No. 932070E</p> 	<ul style="list-style-type: none"><li>• BEFO 1211 12 V / 600 mA</li></ul>
<p>Part No. 932080E</p> 	<ul style="list-style-type: none"><li>• BEFO 1221 with momentum pin</li></ul>
<p>Part No. 932090E</p> 	<ul style="list-style-type: none"><li>• BEFO 1211MB with mechanical blocking</li></ul>

## Other Accessories

<p>Part No. 9135250E</p> <p>Part No. 9135251E</p> 	<ul style="list-style-type: none"> <li>• Additional switch (9135250E)</li> <li>• Switching and breaking contact option</li> <li>• time-unlimited switching</li> <li>• up to 48 V / 2 A</li> <li>• Additional switch with exit button feature (9135251E)</li> <li>• NO/NC contacts</li> <li>• time-unlimited switching</li> <li>• up to 48V/ 2A</li> <li>• Exit button time adj,1 - 6 sec</li> </ul>
<p>Part No. 932928E</p> 	<ul style="list-style-type: none"> <li>• 12 V Transformer</li> <li>• 230 V / 12 V</li> </ul>
<p>Part No. 91341481E</p> 	<ul style="list-style-type: none"> <li>• 12 V / 2 A adapter</li> <li>• A stabilised power supply must be used if a camera is installed. It can also feed the lock and backlight.</li> </ul>
<p>Part No. 9134148E</p> 	<ul style="list-style-type: none"> <li>• SIEMENS<sup>®</sup> adapter</li> <li>• This adapter is required when connecting to a Siemens HiPath Telephone system</li> </ul>



---

## 1.2 Terms and Symbols Used

---

### Terminology

- **Line pick-up/seizure/off-hook** – call start, line locked, busy.
- **Line hang-up/clear** – call end, handset hang-up.
- **DTMF** – dual tone multi-frequency signalling.
- **PSTN** – public switched telephone network.
- **Outgoing call** – 2N<sup>®</sup> Analog Vario-telephone connection made, e.g. by a pressing a button.
- **Incoming call** – telephone-2N<sup>®</sup> Analog Vario connection.
- **Programming mode** – 2N<sup>®</sup> Analog Vario programming mode accessible from by dialling into the intercom only.
- **Code lock** – mode for entering the password for switch 1 or 2 activation using a numerical keypad.
- **Telephone mode** – you can make a call, dial a number and hang up using the numerical keypad.
- **DTMF transmission during call** – for outgoing calls only, numbers are tone-dialled by a numerical keypad button.
- **Button substitution** – the numerical keypad can be used instead of a number pre-stored under a button memory.

## Manual Symbols

The following symbols and pictograms are used in the manual:

### **Safety**

- Always abide by this information to prevent persons from injury.

### **Warning**

- Always abide by this information to prevent damage to the device.

### **Caution**

- Important information for system functionality.

### **Tip**

- Useful information for quick and efficient functionality.

### **Note**

- Routines or advice for efficient use of the device.

## 2. Description and Installation

---

This section describes the **2N<sup>®</sup> Analog Vario** product and its installation.

Here is what you can find in this section:

- **2.1 Before You Start**
- **2.2 Mechanical Installation**
- **2.3 Electrical Installation**
- **2.4 Camera Installation**
- **2.5 Extending Module Connection**
- **2.6 Buttons Labels - Insertion, Replacement**
- **2.7 Mounting - Completion**

## 2.1 Before You Start

---

### Product Completeness Check

Please check the contents of your delivery:

- 1× 2N<sup>®</sup> Analog Vario unit
- 1× Quick installation guide
- 1× User Manual on a CD
- 1× Hexagonal wrench 2/5
- 1× Transparent name plate foil of size A5
- 1× Spare name plate
- 2× Screws
- 2× Dowels





#### **Note**

- If you have bought a complete 'packet', the delivery may contain additional items including instructions for use and lists of available parts.

## 2.2 Mechanical Installation

### Overview of Installation Types

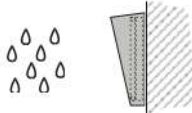
An overview of the installation types and the list of the required components are provided in the table below.

Installation type	Symbol	What you need for installation
Indoor, on surface		2N <sup>®</sup> Analog Vario only
Indoor, flush mounting		2N <sup>®</sup> Analog Vario box with 1-module frame <b>9135351E</b> or box with 2-module frame <b>9135352E</b>
Outdoor, on surface		2N <sup>®</sup> Analog Vario Surface 1-module roof <b>9135331E</b> or Surface 2-module roof <b>9135332E</b>
Outdoor, flush mounting		2N <sup>®</sup> Analog Vario Wall mounting box with 1-module roof <b>9135361E</b> or Wall mounting box with 2-module roof <b>9135362E</b>
Indoor application means		<p>Indoor areas with a low relative air humidity (e.g., hallways, offices and other heated rooms).</p> <p>Indoor areas where <b>humidity condenses</b> on walls <b>but never flows down the walls</b> (porches, storage areas, industrial areas, e.g.).</p> <p>Outdoor areas where <b>protection against rain and water flowing down the wall is provided</b> (sheds, passages. e.g.).</p>

Installation type	Symbol	What you need for installation
Outdoor application means		Environments where the product is exposed to rain or where water may flow down the walls (fence, outer wall of a building, e.g.).

 **Caution**

- The warranty shall not apply to product failures and defects caused by improper installation (contrary to these instructions). The manufacturer is neither liable for damages caused by theft within an area that is accessible after the attached electric lock is switched. The product is not designed as a burglar protection device except when used in combination with a standard lock, which has the security function.

## Surface Mounting

1. Drill holes according to the template included in the 2N<sup>®</sup> Analog Vario supply. Insert the included dowels in the wall holes.

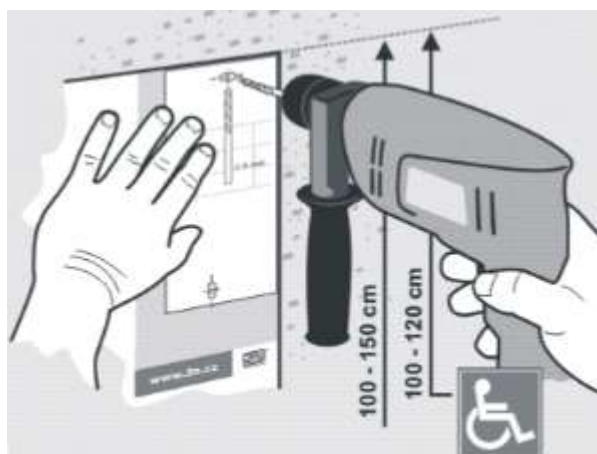

2. Use the hexagon key wrench included in the supply and remove the **2N<sup>®</sup> Analog Vario** metal cover. Remove the screw in the lower part of the metal cover and fold out the cover.

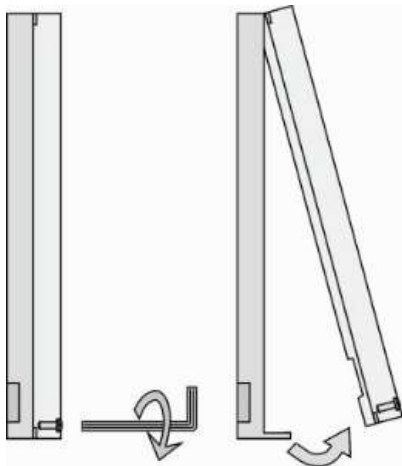

3. Use a cross-head screwdriver to remove the plastic cover and demount the cover.

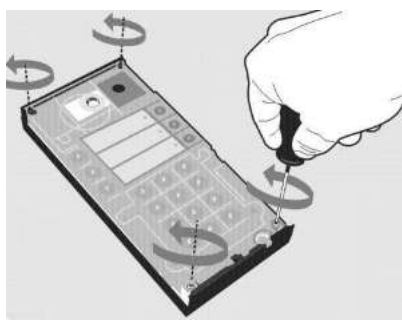

**⚠ Warning**

- Never remove the main board or camera electronics from under the lower cover while installing **2N<sup>®</sup> Analog Vario**. Do not disconnect the camera flat cable from the main board. Do not bend and press upon the flat cable either.

4. In multiple-module assemblies connect the boxes, placing the basic module to the left and the extending modules to the right. The interconnecting cable shall be connected later!

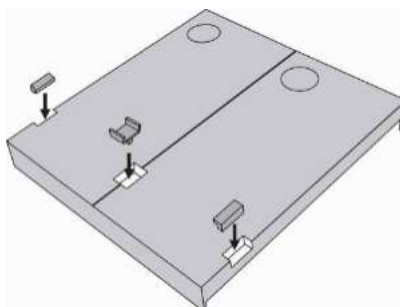

5. Install blank modules on the unused side holes as shown in Figure previous step.
6. If you are installing a roof module, put it on the wall now.
7. Fix 2N<sup>®</sup> Analog Vario on the wall with screws. Carry the supply cables (Ethernet, lock, power cables) to the basic module box through one of the holes. Seal the screw hole carefully with some cement or non-aggressive silicone to avoid water infiltration.

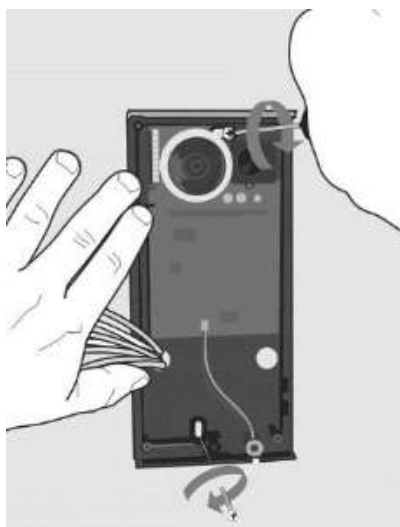

**⚠ Warning**

- Make sure that the mounting surface for the 2N<sup>®</sup> Analog Vario door communicator is perfectly flat. Avoid mechanical overload upon the bottom part of the cover. An incorrect installation on an uneven surface may lead to cover deformation and thus product malfunctions.



8. While installing a roof module, paste its top and side edges to the wall using silicone glue to prevent water from flowing into the box along or around the cables.

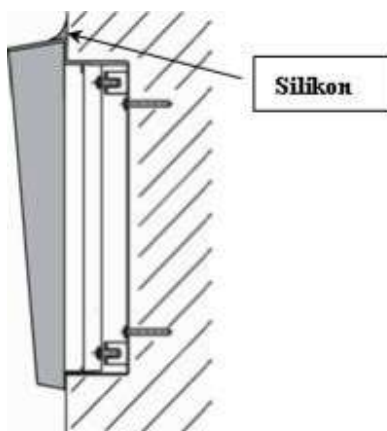

9. Connect the cables as described in subsection 2.4, Mounting - Electrical Installation. Make sure that the cables are not squeezed while installing the plastic cover. For the correct cable installation.

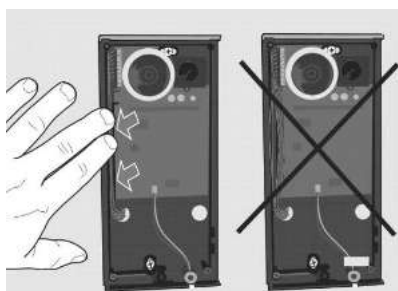

10. Remove the protective foil from the display (for display-equipped 2N<sup>®</sup> Analog Vario versions only).
11. Make sure that the cables are placed properly inside and that none of them obstructs a perfect cover closure.
12. Make sure that the three loudspeaker holder feet fit into the board holes. Keep the required loudspeaker position to make the seal work properly.

13. Having mounted the unit on the wall and connected all cables, replace the plastic cover using cross-recessed screws.

**⚠ Warning**

- Remember to tighten all the four corner screws to fix the loudspeaker seal after electric installation to avoid water in-leak! A PZ1 cross-head screwdriver is recommended.

14. Take out the name plates from the plastic cover. Use a flat-bladed screwdriver, for example.

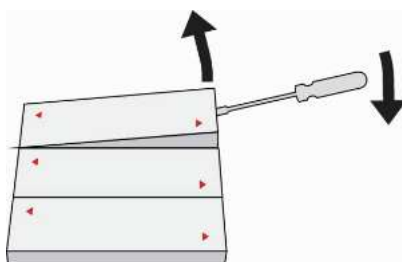

15. Remove the inserts from the name plates.

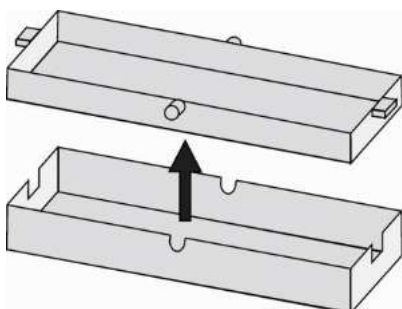

16. Insert the printed foil labels.

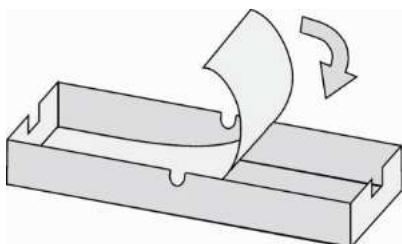

17. Put the inserts back in the name plates.
18. Replace the name plates, clicking them into position. The name plates hold the matt foil inserted underneath.

19. Check whether a silicone seal is inserted in the top groove of the plastic cover. A spare seal package is included.
20. Close the metal cover and fix it with screws.

## Outdoor Installation Rules

- Always connect button backlighting – it is used for heating.
- The joint between the roof module and the wall must be filled with a waterproof cement to prevent water in-leak (see Figure 2.5).
- Water must not leak in along or around the cables.

### **Warning**

- Make sure that all the holes are filled with a waterproof material – top, around the cables and screws – and that a side sealing is ensured.

## Name Tag Material and Printing

Each 2N<sup>®</sup> Analog Vario package includes a sheet of transparent foil for laser printing. Cut the printed foil into pieces and insert the labels in the name plates. Do not use paper to avoid water in-leak and paper damage.

Red arrows are printed on the name plate. Make sure that the text and the arrow do not overlap. We recommend you to use a template (MS Word) available at [www.2n.cz](http://www.2n.cz) for printing.

## Flush Mounting

Follow the installation instructions included in the flush mounting box delivery.

### **Caution**

- The warranty shall not apply to product failures and defects caused by improper installation (contrary to these instructions). The manufacturer is neither liable for damages caused by theft within an area that is accessible after the attached electric lock is switched. The product is not designed as a burglar protection device except when used in combination with a standard lock, which has the security function.

---

## 2.3 Electrical Installation

---

### Compatibility

2N<sup>®</sup> Analog Vario is designed for conventional, analogue telephone lines and works regardless of polarity and line parameters.(Refer to the Technical Parameters) and uses tone (DTMF) or pulse dialling to be programmed. Normally, it is connected to a PBX line however It can also be connected to an analogue line or the GSM interface providing a wireless installation.

### Connection to Telephone Line

Connect 2N<sup>®</sup> Analog Vario simply using LINE terminals. The advantage is that 2N<sup>®</sup> Analog Vario requires no power supply because all power is fed from the telephone line - except for the button backlight and electric lock, if connected. Nevertheless, 2N<sup>®</sup> Analog Vario can work without these circuits too and sends an acoustic signal on having been connected to a line (or after having been disconnected from the line for a defined period of time).

### Printed Circuit Board (PCB) Description

Explanatory notes to the figure:

1. Terminal board
2. Left button connector
3. Display connector (for version 10 only)
4. Voice memory
5. One-chip Hands-Free telephone
6. Switch 2 connector
7. Keypad backlight connector
8. Connector for non-standard functions
9. Microphone connector
10. Keypad connector
11. Extension unit connector
12. Serial number
13. Main microprocessor

- 14. Configuration jumper block
- 15. Right connector
- 16. Jumpers
- 17. Camera connector
- 18. Camera setting jumpers
- 19. Loudspeaker connector and panel grounding

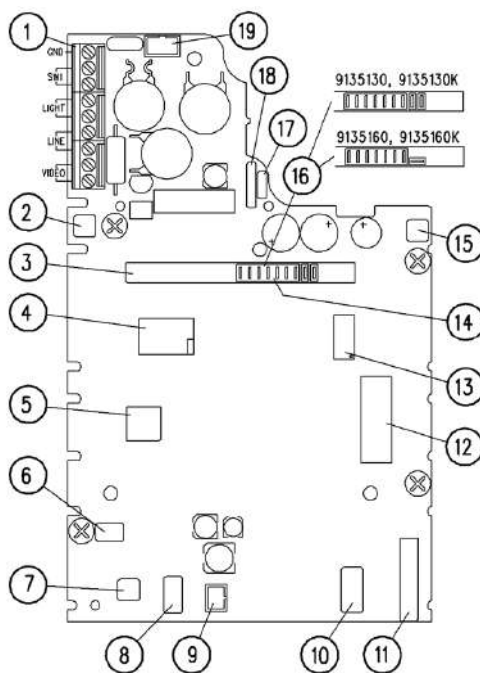

PCB Layout, Version 10

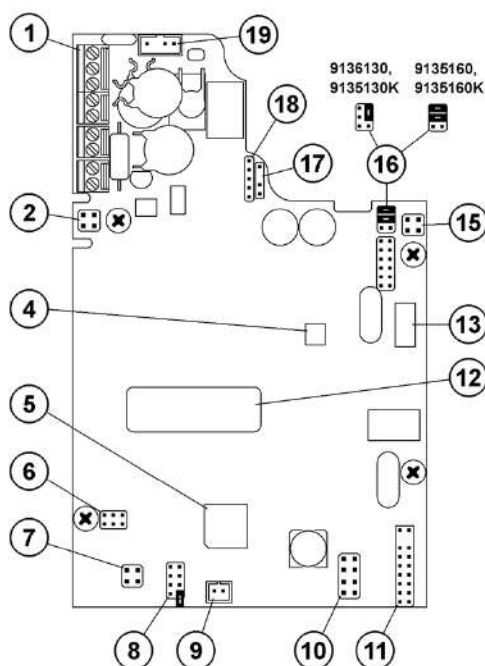

PCB Layout, Version 14

## Description of Terminals

- **GND** - This terminal protects 2N<sup>®</sup> Analog Vario against static electricity damage.
- **SW1** - Switch 1 designed primarily for electric door lock control.
- **LIGHT** - These two terminals are connected to the 12V power supply with arbitrary polarity. The power supply can feed the electric lock too.
- **LINE** - These two terminals are connected to the analogue telephone line with any polarity.
- **VIDEO** - Video signal output - used only if a camera unit is included. The coaxial cable is connected with an internal conductor to +, with shielding to -.

## Description of Jumpers

Connector (8)

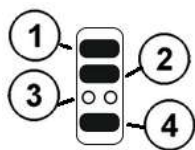

1. Here connect the current call indicator (LED).
2. Write-protection (if the jumper is mounted).
3. do not connect
4. **Microphone sensitivity reduction** (mount the jumper for noisy environments).

Camera setting - connector (18): refer to the instructions enclosed to the camera unit.

## Parallel Connection

Parallel connection of multiple telephone sets was commonly used in the era in which telephone lines were rare, It carries unnecessary risks to connect the unit in this way. It is in no case recommended to connect 2N<sup>®</sup> **Analog Vario** in parallel to another telephone or another 2N<sup>®</sup> **Analog Vario** door communicator. It is neither admissible to use equipment that switches one line between two or more sets (intelligent double branch, etc.).

## Typical Electric Lock Connection

2N<sup>®</sup> Analog Vario contains a solid-state switch equipped with V-MOS transistors, which is able to switch both ac and dc regardless of polarity. Make sure that the current and voltage values do not exceed limits (refer to the Technical Data) and that the technical parameters of the lock and power supply are compatible.

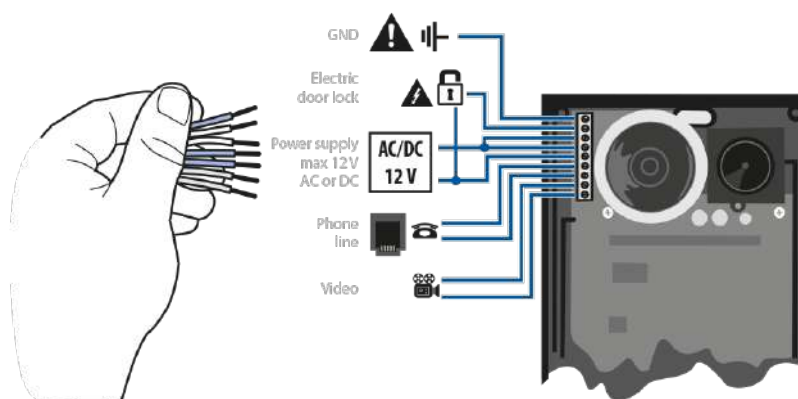

### Warning

- Never switch 230 or 120 V mains voltage directly!!!

If you do not have an electric lock and want to have one, you should select a 12 V lock, this being the most common type. Connect the lock according to the figure, which shows the button backlight supply too (see later).

Dc-supplied lock: Practically all locks can be dc and ac supplied. The ac supply is more advantageous because the lock buzzes, which is the clearest signalling method however to use a dc supply lock (from batteries, e.g.), you are recommended to equip

2N<sup>®</sup> Analog Vario with acoustic signalling (continuous tone during the whole switch activation time).

### Caution

- If the lock power supply fails and the telephone system carries on working, the keypad-equipped 2N<sup>®</sup> Analog Vario system is unaware of the failure the switch will be password-activated and the activation is acoustically signalled, but the electric lock will not work because of the lack of power.



## Typical Backlight Power Supply

2N<sup>®</sup> Analog Vario features a high-quality white-LED name plate backlight. This backlight shows low power requirements, long life and even illumination of all name plates. If a standard 12 V electric lock (see above) is connected to 2N<sup>®</sup> Analog Vario, the backlight can be powered using the lock power supply. Connect the power supply as shown in the figure. Just make sure that the power supply (adapter transformer) is able to supply the required current *constantly* and that it is cooled properly (do not wrap it in any thermally insulating material, or use ill-ventilating covers, etc!). The required current depends on the count of buttons and other elements in the set and can be determined for 12 V according to the following formula:

- Basic unit without keypad: 80 mA
- Basic unit with keypad: 200 mA
- 1 one-side extender unit: 80 mA
- 1 two-side extender unit: 100 mA
- Camera: 130 mA

*The above mentioned currents are maximum values at 12V.*

## Cable Arrangement inside the Cover

We recommend you to use a UTP cable (8-wire, approx. 5.5 mm output diameter) for 2N<sup>®</sup> Analog Vario connection. Push the cable into the groove on the left side of the cover. If you combine this cable with another one (e.g. the electric lock 2-wire cable), insert the 2-wire first and then the UTP cable to prevent the 2-wire cable from falling out. You can also fit the cables with common clamp tape.

### **Warning**

- An improper cable arrangement may cause a malfunction of the product. Before closing the cover, check all wires and the cover for perfect closing.

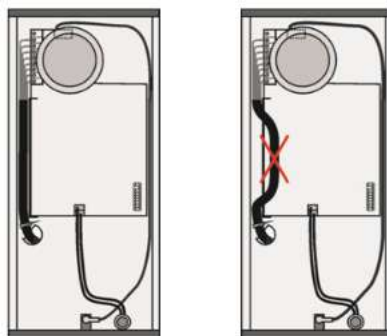

## Grounding Terminal Connection - Mandatory

Any person that gets in contact with 2N<sup>®</sup> Analog Vario may carry an electrostatic charge of several thousands of Volts. Drawing one's finger near to the 2N<sup>®</sup> Analog Vario metal panel may result in spark discharge. The purpose of the grounding terminal is to protect the product against this discharge. The terminal carries the charge from the panel to the ground directly, not through the 2N<sup>®</sup> Analog Vario circuits.

Where no grounding cable is available, it is possible to connect the grounding terminal with any of the telephone line terminals\*). In some telephone systems one line terminal is directly connected with the ground, the others carry current to the ground through overvoltage protection.

### Note

- This connection eliminates direct connection of the line conductor onto the panel because there is a protective element between the panel and the grounding terminal.

## Separate Backlight and Electric Lock Supply

Separate power supplies are necessary where the lock requires voltage higher than 12 V. In this case, an additional power supply (12 V) must be used to illuminate the button backlight - see the figure below. Other reasons for such connection are the effort to minimise consumption from the back-up supply (which supplies the lock, not the backlight), or just that two weaker power supplies are available

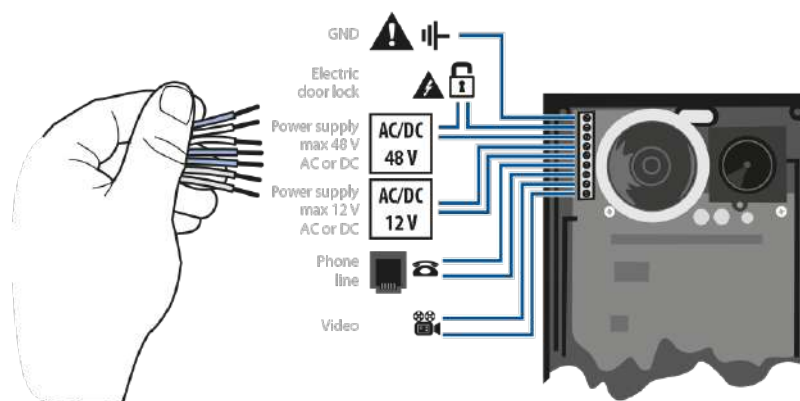

## Connection of Switch 2

A new additional switch, Part No. 9135250E, has been designed for 2N<sup>®</sup> Analog Vario. It can be mounted into any basic unit, as an added option. To connect it, follow the instructions included in the switch delivery.

## 2.4 Camera Installation

---

The camera unit, Part No. 9135210E, can be built into any **2N<sup>®</sup> Analog Vario** basic unit during installation or as an option to be added later. You can also use the camera unit in combination with any Vandal resistant panel. It is a colour CCD camera with high resolution of 420 TV rows, with a monochrome night mode (infrared backlight hidden under the nameplates), and has a wide-angle pin-hole lens (90° diagonally) and a tilting hinge for manual direction adjustment.

The camera has a PAL composite output and can be connected to any TV display, or a video server (Part No. 9134137, MPEG4 LAN video server). A coaxial or twisted cable can be used for connection.

A sight glass is included in the delivery, which replaces the non-transparent **2N<sup>®</sup> Analog Vario** basic unit sight glass imitation. To install the camera, follow the instructions that come with it.

### **Caution**

- To install the camera, use the stabilised 12 V dc power supply. To get a suitable (12 V / 2 A) one, order Part No. 91341481E.

## 2.5 Extending Module Connection

2N<sup>®</sup> Analog Vario features an easy installation of extending button modules. Extending modules are connected using a single cable (included in every extender delivery) in a chain pattern (every additional unit is connected with the previous one). Each extending module has two connectors - an input connector (for connection towards the 2N<sup>®</sup> Analog Vario basic unit) and an output connector (for connection of another, more remote unit). Be sure to maintain the correct orientation of the units and avoid connector mismatch to ensure a proper function of the device!

### Module Cable Interconnection

- The cable is included in every extending module delivery. Both its ends are the same. Configuration is 1:1. Connectors cannot be shifted or inserted conversely because they are equipped with a so-called key.
- The basic unit is always on the left. Extenders are chain-connected, i.e. each is linked with its neighbour.
- The cable cannot be driven through the box interconnecting holes until the boxes have been connected (see subsection 2.3 Mounting - Mechanical Installation).

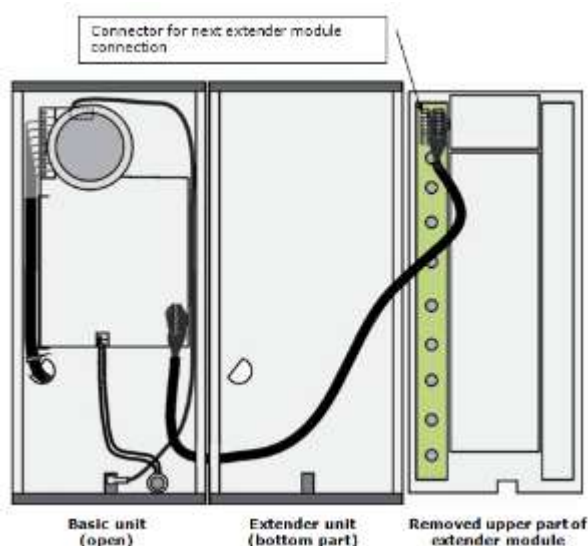

8-Button Extender Module Connection to Basic Unit

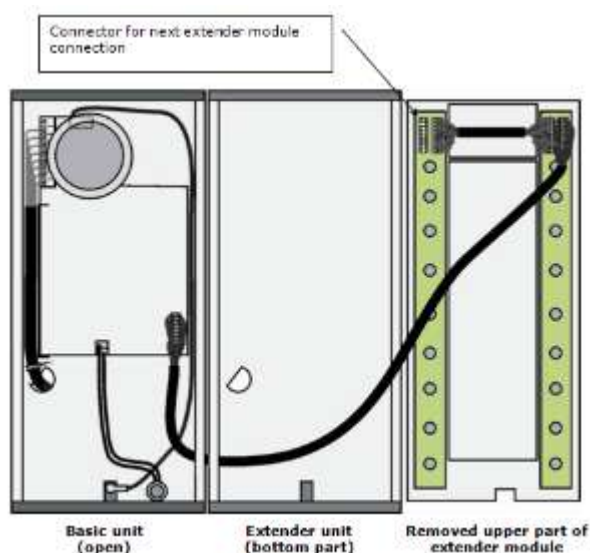

### 16-Button Extender Module Connection to Basic Unit

#### **Caution**

- Extension modules must be interconnected by mounting jumper (tunnel), delivered together with each extension unit. This part is made from conductive plastic. If it is necessary to place extender unit at some distance, or if you lost the jumper, you must interconnect metallic covers by another way.

### Maximum Count of Extenders

9135181E (1×8 buttons)	6	5	4	3	2	1	0
9135182E (2×8 buttons)	0	0	1	1	2	2	3

The table above shows how to combine modules with single (whole) and double buttons.

## Button Numbering

### Button numbering - whole-button sets

	1		7		15				23
	2		8		16				24
	3		9		17				25
			10		18				26
			11		19				27
			12		20				28
			13		21				29
			14		22				30

Also applies to keypad sets

It is possible to continue to 54

### Button numbering - double-button set

			7		15	23		31	39	47
1		4	8		16	24		32	40	48
2		5	9		17	25		33	41	49
3		6	10		18	26		34	42	50
			11		19	27		35	43	51
			12		20	28		36	44	52
			13		21	29		37	45	53
			14		22	30		38	46	54

Also applies to keypad sets

#### Caution

- Installing the info panel name plate, order No. 9135311E, into any of the extending modules will not change the numbering system (the buttons on the info panel sides will remain functional).
- Connecting the info panel module, order No. 9135310E, will result in omission of eight numbers.

## 2.6 Buttons Labels - Insertion, Replacement

### Instructions

1. Remove the 2N<sup>®</sup> Analog Vario metal cover. To do this, use a hexagonal key, unscrew the screw as shown in the figure and take the cover off.

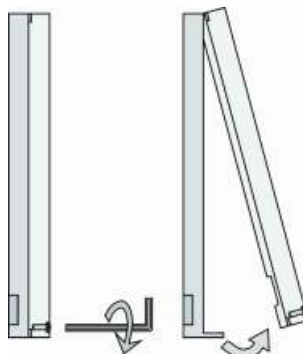

2. Remove the name plates as shown in the figure using, e.g., a screw driver.

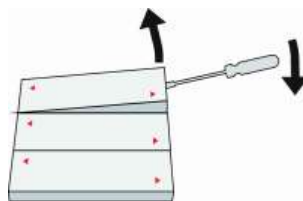

3. Remove the name plate inserts as shown in the figure.

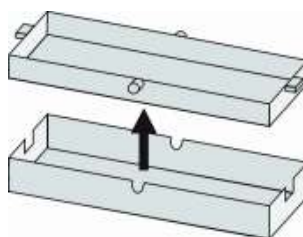

4. Insert the labels printed on foil (see later).

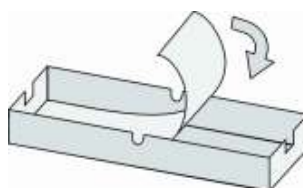



5. Replace the name plate inserts.
6. Put the name plates back in the depression and click into position. The name plates keep the matt foil steady.
7. Replace and screw on the metal cover.

**i Note**

- You can remove the name plates even without removing the metal cover however damage, if any, incurred as result of this, is not covered by the warranty.

## Label Material and Printing

Every 2N<sup>®</sup> Analog Vario delivery includes a sheet of transparent foil that can be easily printed, with a laser printer. Cut the printed foil into pieces and insert the labels into the name plates. Do not use paper to avoid water logging.

Make sure that the text does not cover up the red arrows printed on the name plate, we recommend you to print the foil using a template (MS Word), available at [www.2n.cz](http://www.2n.cz) in section "Downloads", direct link: **Template - name tags**

Single surface button	Horizontally split button
Name 01	Name 01 Name 04
Name 02	Name 02 Name 05
Name 03	Name 03 Name 06

✔ **Button numbering**

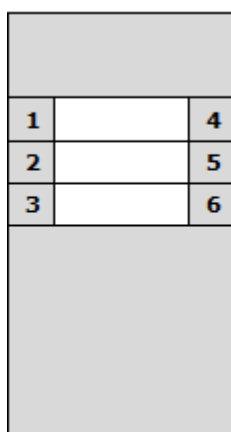
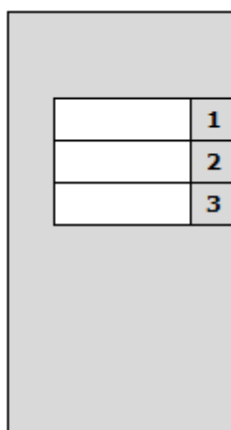
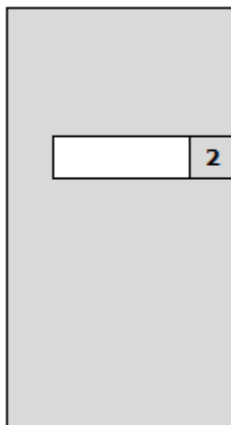

## 2.7 Mounting - Completion

1. Remember to seal the 2N<sup>®</sup> Analog Vario cable passage hole properly to avoid moisture in-leak and damage to electronics due to condensation.
2. Make sure that the wires inside 2N<sup>®</sup> Analog Vario are not squeezed and insert the plastic top cover (a transparent plastic mould) carefully making its contacts plug into the electronics board connectors. Push the plastic cover into position moderately. If the part swings over an obstacle or one corner is higher than the others, remove the cover and find the obstacle. Then tighten the corner screws properly.
3. Mounting the metal cover follow the steps included in the subsection dedicated to name plate removal. Make sure that the cover fits well and is perfectly flat. If its bottom part is loose, the mounting wall is probably uneven. Support the corners to avoid 2N<sup>®</sup> Analog Vario bending.

### Caution

- An improper mounting may significantly deteriorate the button function.
- A poor outdoor mounting may cause water in-leak and damage to the electronics.

### Most Frequent Mounting Errors

For illustration, a part of the plastic cover is removed in the figures below to reveal the sealed loudspeaker and the cover-seal touch point. The cross section plane is marked white for better orientation.

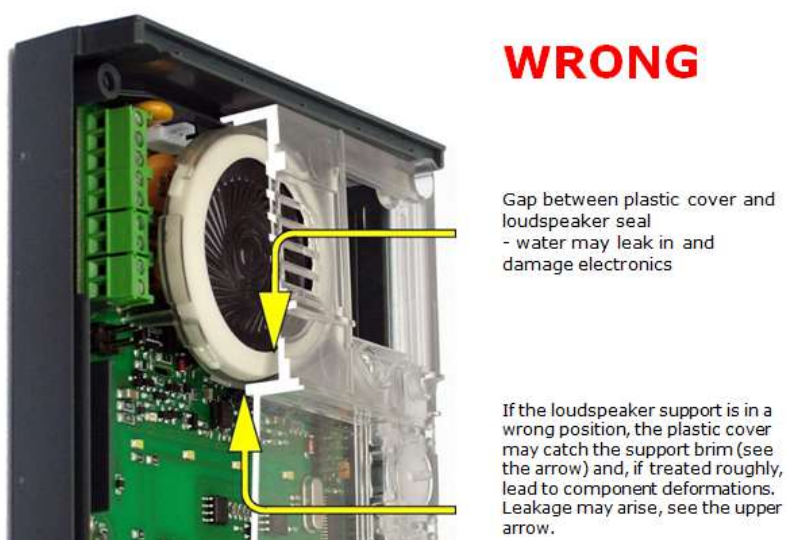
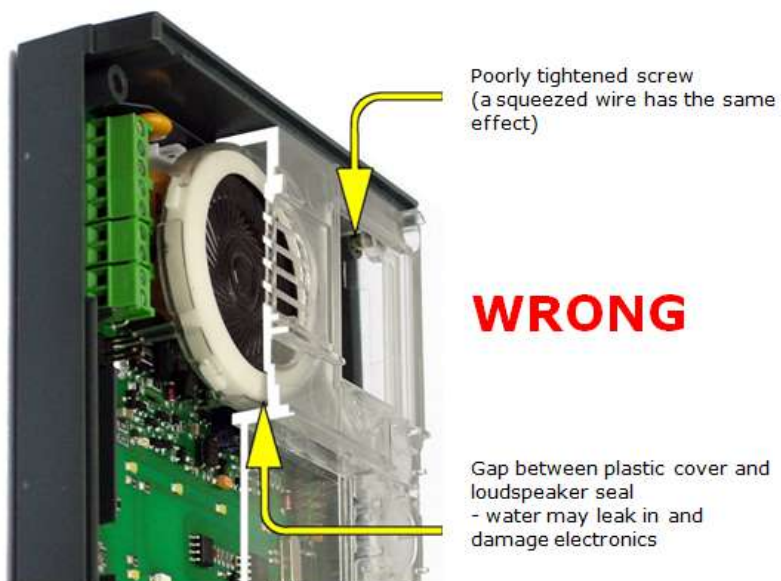

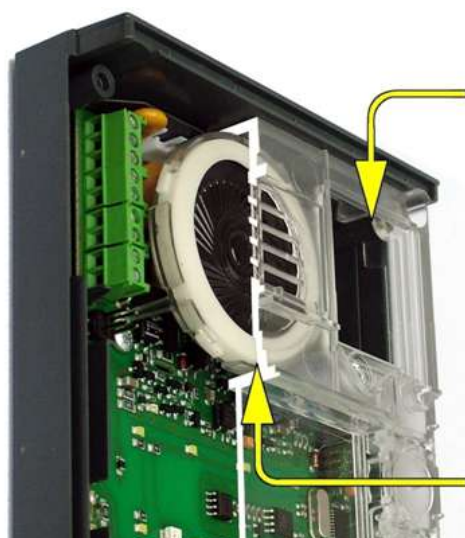

Properly tightened screw

**RIGHT**

The seal touches the plastic cover. Water flows out through a small hole (not shown in the figure).

Note: Water does not affect the loudspeaker Mylar membrane.

## 3. Function and use

---

This section describes the **2N<sup>®</sup> Analog Vario** configuration.

Here is what you can find in the section:

- **3.1 Programming**
- **3.2 Full Parameter Chart**
- **3.3 Function Description**
- **3.4 Section for Advanced Users**
- **3.5 Maintenance**
- **3.6 Downloads**

## 3.1 Programming

---

All 2N<sup>®</sup> Analog Vario parameters, including the keypad ones, are set remotely using any tone-dialling telephone set (or a mobile phone). First call 2N<sup>®</sup> Analog Vario and enter the programming mode. The access to this mode is service password protected. A voice menu is available in the programming mode and so you need not use this manual to program standard parameters. The menu is stored in the 2N<sup>®</sup> Analog Vario memory in the default language. Having entered the full parameter or memory number, you can hear how the parameter has been programmed, thus checking the programmed numbers for correctness.

All parameters are stored safely in the non-volatile EEPROM memory. The memory capacity does not limit the count or length of numbers, passwords, etc. This means that altogether 324 memories for 16-digit telephone numbers, 54 Arrival/Departure password memories, 20 switch password memories, etc. are available.

### Tip

- Write or print the values to be programmed to minimise the risk of error. Moreover, this gives you an idea of what you have programmed. Make sure that programming is not barred (JP1 jumper) – refer to the PCB Description subsection



### Entering Programming Mode

You can enter the programming mode only during an incoming call (telephone – 2N<sup>®</sup> Analog Vario call). The programming barring jumper must not be mounted. To get into the programming mode, enter the service password in the format  password  (do not forget to enter the asterisks before and behind the password!). The service password is 12345 by default and can be changed „. If you enter the password correctly, the voice menu is launched. Now you can start programming.

## Programming Procedure















You can set parameters in any order and as many times as you wish. To change a parameter use the following command:

Parameter number  parameter value 

A three-digit **parameter number** is assigned to every parameter to be programmed and to every memory (refer to the Programming Chart). This number indicates to **2N<sup>®</sup> Analog Vario** which parameter to change, and  is used as "Enter". When it is entered, **2N<sup>®</sup> Analog Vario** repeats the parameter (or memory) number and reads the current contents (excluding passwords). Now you can enter new data – of variable meaning and length depending on the parameter selected (refer to the Full Parameter Chart). Finally, press  again for confirmation. **2N<sup>®</sup> Analog Vario** confirms the data saving. Repeat this procedure for each parameter.

## Switch Password Programming

Each switch can be controlled with up to 10 different passwords that are listed in the **2N<sup>®</sup> Analog Vario** memory. Passwords can be added to the list using functions 811 and 821 and deleted with functions 812 and 822 individually. The default status is a single password in the list, namely **00** for switch 1 and **11** for switch 2. These two special passwords cannot be entered from the **2N<sup>®</sup> Analog Vario** keypad. To cancel them, you have to remove them from the list:

       or       

Function 997 deletes the entire password list for both switches including the passwords 00 and 11. Function 999 deletes the entire password list for both switches too but recovers the passwords 00 and 11 and the service password 12345.

## Password Selection Restrictions



Controlling the switches by phone, you can enter the password without any starting and terminating characters and the password length is not limited. **2N<sup>®</sup> Analog Vario** has to verify after every character received whether the password is complete or not. Therefore: make sure that no password is identical with the beginning of another password.

- Should you use such confusing passwords for switch control, you have to enter the longer password (by phone) with asterisks at the beginning and end.





- If **2N<sup>®</sup> Analog Vario** refuses to store a password, it means that the switch password list is full, or the password has already been entered.
- The switch password may not be identical with any Arrival/Departure, Day/Night, or service password.
- For password selection tips see the Instructions for Keypad Use.

## Programming Error

- Any wrong value can be re-programmed by another command (immediately or any time later).
- If you make a typing error, cancel the entered value with  . Then you can re-enter the whole number.
- If you enter an incorrect parameter number or parameter value, **2N<sup>®</sup> Analog Vario** sends a refusal signal and you have to start with the parameter number again.
- If you do not press any button within a predefined timeout, **2N<sup>®</sup> Analog Vario** sends a hang-up signal and hangs up. The timeout is 5 seconds; every  character is followed by 30 seconds for you to think over your setting. The 5-second limit starts when **2N<sup>®</sup> Analog Vario** has read all that relates to the current user position in the programming menu. The timeout can be prolonged - see the chart.

### Tip

- **To check programmed values:** enter parameter number and  , listen the parameter value and press  for return to the main menu.

## Deleting All Passwords, All Memories, Complete Initialisation

The following three functions facilitate your programming by clearing all previous settings:

- **997** - deletes the entire password list for both switches including passwords 00 and 11.
- **998** - deletes memories of all buttons (01-54) plus Arrival/Departure and Day/Night passwords.
- **999** - clears the whole memory and resets the default values (see the chart).

## Protection against Unintentional Deletion

The above functions need no special "value" but must be protected against unintentional initiation. Therefore, enter the service password as the value. Warning:

Full initialisation takes a few seconds, 2N<sup>®</sup> Analog Vario sends a continuous tone while memory clearing. Functions 997 and 998 take a little less time and are signalled by a continuous tone too.

The button memories can be deleted individually too - just enter a "blank" while programming. For example:      clears memory 1 of button 01.

## If You Forget the Service Password

If you forget the service password, contact the manufacturer. The manufacturer can change your service password to 12345 remotely without altering any other parameter.

## 3.2 Full Parameter Chart

Parameter (function)	Parameter Name	Range	Default	Note
011 to 546	All button memories	Up to 16 digits	blank	<p> <math>\overline{XX} \overline{X} \overline{X} \overline{X}</math> NUMBER             <math>\overline{X}</math> Memory number, 1 - 6             <math>\overline{XX}</math> Button number, 01 - 54         </p> <p><i>Note 1: The 02x parameter is always programmed for the singlebutton model 2N<sup>®</sup> Analog Vario.</i></p>
Digits 0-9 can only be entered directly into the memories. Special characters are entered additionally using function XX7:				
017 to 547	Enter special chars $\overline{X}$ , $\overline{\#}$ and space			<p> <b>Entering format:</b>   <math>\overline{XX} \overline{7} \overline{X} \overline{X} \overline{XX}</math>             Button number, 01 - 54                       1 = <math>\overline{X}</math> 2 = <math>\overline{\#}</math> 3 = space                       Button memory number, 1 - 6                       Character position, 01 - 16             <i>Note: The digits behind this position are shifted automatically.</i> </p>
018 to 548	Count of automatic dialling cycles	0-9	0 = off	<p> <math>\overline{XX} \overline{8} \overline{X}</math>   <math>\overline{X}</math>             Count of cycles, 0 - 9                       Button number, 01 - 54         </p>
019 to 549	Arrival /Departure password	up to 16 digits	blank	<p> <math>\overline{XX} \overline{9} \overline{X}</math> PASSWORD             <math>\overline{X}</math> Up to 16 digits             <math>\overline{XX}</math> Button number, 01 - 54         </p>
559	Day/Night password	up to 16 digits	blank	The same as for Arrival/ Departure, identical for all buttons

Parameter (function)	Parameter Name	Range	Default	Note
811	Enter up to 10 switch 1 passwords	up to 16 digits	00	<ul style="list-style-type: none"> <li>• Passwords 00 and 11 cannot be entered from the keypad!</li> <li>• Up to 10 switch passwords</li> <li>• Delete passwords using functions 812, 822</li> </ul>
821	Enter up to 10 switch 2 passwords		11	
812	Delete valid switch 1 passwords	Valid password		Deletes individual valid switch 1 passwords.
822	Delete valid switch 2 passwords			Deletes individual valid switch 2 passwords.
813	Switch 1 closing time	0-9 s	5 s	0 = switch disabled
823	Switch 2 closing time	0-9 s	5 s	0 = switch disabled
824	Switch 2 delay	0-25 s	0	0 = switch 2 is not synchronised with switch 1
901	Dialling type	0-1	0 = tone	1 = pulse 40/60
902	Dialling timeout after pick-up	5-99	8 = 0,8 s	Range of 0,5 s - 9,9 s
903	DTMF transmitting level	0-12	6	1 step = 1 dB



Parameter (function)	Parameter Name	Range	Default	Note
904	Automatic Multiple Number Dialling type	0-4	0 = disabled for all buttons	1 = loud with confirmation 2 = silent with confirmation 3 = SP without confirmation 1) 4 = SP without confirmation 1)
906	Ticking into call	0-12	0 = off	The called party recognises better that the incoming call is from the intercom.
911	Count of rings before incoming call answering	1-99	2	 Warning!!! No connection is established if a higher value is entered than as allowed in the PBX ringing timeout!!!
912	Max. call duration	1-99	12 = 120 s	Range of 10 s - 990 s
913	Log-in timeout	1-99	3	3 = 30 seconds
915	Hang-up time between calls	5-99	15 = 1,5 s	
921	Code lock mode	0-1	1 = enabled	0 = disabled 1 = enabled
922	Buttons replaced by keypad	0-1	0 = disabled	For details on these functions see the Keypad Description.
923	Telephone mode	0-1	0 = disabled	
924	Tone dialling during call	0-1	0 = disabled	

Parameter (function)	Parameter Name	Range	Default	Note
931	Microphone power-up level	0-3	2	0 = Maximum microphone sensitivity
932	Automatic response speed	0-3	2	3 = Maximum response speed
933	Reception volume	0-15	7	15 = Maximum reception volume
934	Transmission volume	0-15	7	15 = Maximum transmission volume
935	Message volume	0-15	7	15 = Maximum message volume
936	Beeping volume	0-12	12	12 = Maximum tone volume
937	DTMF hearing (side tone) volume	0-3	3	3 = Maximum DTMF volume
938	Loudspeaker volume	0-15	7	15 = Maximum loudspeaker volume
941	Minimum continuous tone time	10-99	20 = 2s	If the tone is longer, the intercom hangs up.

Parameter (function)	Parameter Name	Range	Default	Note
942	Minimum busy tone or pause duration	0-255	8 = 0.08 s	These parameters control the busy tone detection. They are used for call termination and automatic dialling.
943	Maximum busy tone or pause duration	0-255	70 = 0.7 s	
944	Maximum tone-pause difference	0-255	10 = 0.1s	
945	Minimum count of busy tone periods	2-9	4	
946	Dual tone detection setting	0-10	4 = 440 Hz	

Parameter (function)	Parameter Name	Range	Default	Note
951	Minimum ringing tone time	1-200	50 = 0,5 s 2)	The longest ringing period pause must be in the interval between parameters 952 and 953.
952	Minimum long pause time	5-100	10 = 1 s	 Warning! As these parameters also detect incoming calls, an incorrect setting may result in the intercom not answering the call!
953	Maximum long pause time	10-100	60 = 6 s	
954	Count of ringing periods	1-99	10	If the preset count of periods is exceeded, the call is terminated.
<p>If the preset count of periods is exceeded and automatic dialling is enabled, another attempt follows. In the event of Automatic Dialling <u>without Confirmation</u>, the ringing tone is recognised and ends before the preset count of periods is exhausted; the call is regarded as successful.</p>				
961	Maximum timeout for pressing the next digit	1-9	5 s	During password entering, etc.
963	Possibility to hang up by pressing the same button	0 = no 1 = yes	1	
964	Possibility to dial the next number by pressing 2nd button	0 = no 1 = yes	1	



Parameter (function)	Parameter Name	Range	Default	Note
971	Count of message repetitions	0-9	3	There is a 3-second pause between every two messages.
974	Intercom identification number	16 digits	-	The number enables intercom identification.
975	Message options for automatic multiple number dialling	2 digits	55	<p><b>1st digit</b> = type of message repeated after dialling.</p> <p><b>2nd digit</b> = type of message after confirmation.</p> <p>The following digits are used:</p> <p>2 = identification (974) - loud speaking</p> <p>4 = identification (974) - DTMF</p> <p>5 = message as defined in par. 977 (after confirmation by par. 976)</p> <p>7 = confirming tone (after confirmation only)</p>
976	language selection for a message	0-8	1	<p>0 = </p> <p>1 = English</p> <p>2-3 = </p>
977	language selection for "wait, please" message	0-8	1	<p>4 = German</p> <p>5-7 = </p> <p>8 = Portuguese</p> <p>9 = Dutch 10 ... 99 = silence</p> <p>Note:</p>
				<p>See <b>Survey of messages</b> in Subs. 4.2</p> <p><b>Caution!</b> Czech version has language order: 1 = Czech, 2 = English</p>

Parameter (function)	Parameter Name	Range	Default	Note
991	Service password		12345	12345 by default
995	Software version identification		—	This function reads out the current software version. Format: year-month-day. Writing disable.
997	Deletion of all switch passwords	Service password	12345	Deletes password 00 too.
998	Clearing of all memories		12345	Clears memories 01 to 55.
999	Full initialisation		12345	Warning! Changes the service password too (setting the default value of 12345).

### Notes

- Terminology: For the purpose hereof, **parameter** means a **value** that is stored in the 2N<sup>®</sup> **Analog Vario** memory and can be re-programmed. **Function** is a means of execution of another service such as initialisation, software version identification and so on.
- 1) Types 3 and 4 of Automatic Dialling without Confirmation differ from each other in how they process very short calls (a few seconds). Dialling type 4 regards a call as successful in all cases, type 3 only if the door was opened.

## Explanation of Some Parameters

### 824 - Second Switch Synchronisation

Set the parameter to a non-zero value to make switch 2 activate automatically with a defined delay if switch 1 is activated. Useful where two doors are close to each other.

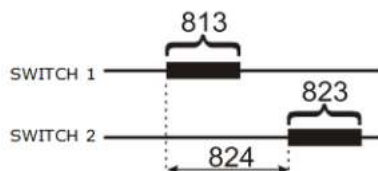

(The numbers in the figure are parameter numbers.)

The parameters can be set to overlap activation of the two switches:

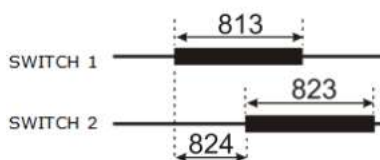

### Explanation of Parameters 951, 952, 953

Ringing tone (example)

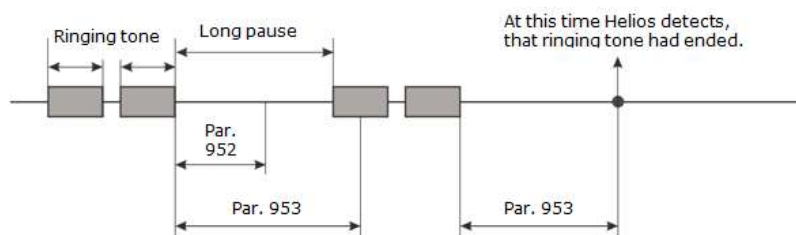

### Explanation of Parameters 942, 943, 944

Busy tone

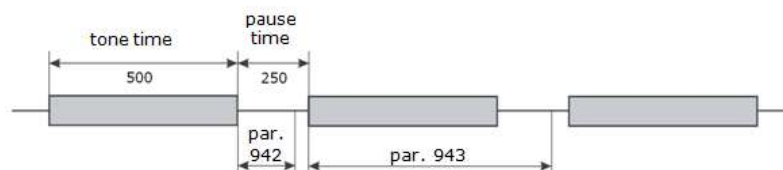

### Example:

The busy tone in the figure above is considerably longer than the pause time. Therefore, set parameter **942** according to the pause, to 200 ms, e.g., and parameter **943** according to the tone, to 600 ms, for example. In this case, however, the default values can be maintained for both the parameters. Since the tone - pause difference is  $500 - 250 = 250$  ms, set parameter 944 to 300 ms, for example.

#### **Note**

- Increase parameter 944 also when **2N<sup>®</sup> Analog Vario** is placed in a hall or corridor with a large decay time.

---

## 3.3 Function Description

---

### From External User's View (Visitor)

Like normal Doorbells, 2N<sup>®</sup> Analog Vario buttons are provided with labels the visitor finds the appropriate button (e.g. Mr. Smith) and presses it this activates 2N<sup>®</sup> Analog Vario to then dial the number pre-programmed for under that button, the visitor can then hear the ringing tone from the loudspeaker and the required (Mr. Smith's in this case) telephone is ringing. If the 2N<sup>®</sup> Analog Vario unit is connected to a telephone system you may be able to tag the port that 2N<sup>®</sup> Analog Vario is connected to so that you can see on the ringing phone that it is 2N<sup>®</sup> Analog Vario that is calling. When the called party answers the call, the visitor and tenant can speak to each other and if an electric lock is connected to 2N<sup>®</sup> Analog Vario, the called person can open the door by entering the correct password on the telephone keypad to activate the door or barrier. When the caller hangs up, 2N<sup>®</sup> Analog Vario detects the PBX or analogue line tone and hangs up too. 2N<sup>®</sup> Analog Vario also hangs up when it "hears" the busy tone or if the call takes more time than pre-programmed to connect. You can pre-program the amount of time that you have to speak into the microphone however when you are reaching the programmed time the unit gives a warning tone 10 seconds before hanging up so that the called party can extend the call if required.

### **i Notes**

- If the visitor presses another button during the call, **2N<sup>®</sup> Analog Vario** hangs up for a few seconds before dialling the new number.
- If a button is pressed that has no number stored within it **2N<sup>®</sup> Analog Vario** picks up the line, sends a refusal tone (refer to the Signals Overview) and hangs up.
- If the visitor presses the same button during the call, **2N<sup>®</sup> Analog Vario** may hang up (can be programmed to stop this feature if required).
- The above mentioned rules are only applied if the Automatic Multiple Number Dialling mode is OFF. For this special mode refer to the Automatic Multiple Number Dialling section.

## **Function Description – Numerical Keypad Models**

The **2N<sup>®</sup> Analog Vario** basic units, Part Nos. **9135130K** and **9135160K**, are equipped with a numerical keypad. The keypad provides a number of functions:

- traditional code lock
- features as if a normal telephone set
- DTMF transmission during an outgoing call
- substitution of up to 54 buttons

The keypad features a smart metal design and very favourable price to performance ratio. For the description of the functions from the user's view see below.

## **From Internal User's View (Survey of Functions)**

### **Calling to 2N<sup>®</sup> Analog Vario**

You call the appropriate extension and **2N<sup>®</sup> Analog Vario** makes the call and gives a confirmation tone after two rings (or as pre-programmed). Now you can speak and control the 2 switches, program **2N<sup>®</sup> Analog Vario** (see later), and listen to what is going on outside and speak to the calling party if desired.

## Door opening

2N<sup>®</sup> Analog Vario contains a switch to which an electric lock can be connected (not included in this pack). This switch can be telephone keypad controlled using a (digital) password in two ways as shown in the default password 00 example below:

00 or \*00\*

The switch activation time can be programmed once the switch is enabled this will also automatically terminate the call in the next 30 seconds.

### **Note**

- If the Automatic Multiple Number Dialling with Confirmation or the Silent Automatic Multiple Number Dialling with Confirmation mode is selected and the password starts with digits 1 to 5, an asterisk must always be used.
- **You Must** enter every digit in the password within five seconds (or as pre-programmed) to avoid 2N<sup>®</sup> Analog Vario from hanging up.

## Switch 2 activation (light, e.g.)

The second switch (if an additional switch is installed) can be controlled in the same way.

## Switch 2 synchronisation

Switch 2 can also be used to delay the opening of another door. Once the switch 2 delay timeout is programmed, the second switch is synchronised automatically with the first one, the delay being 1–25 seconds.

## Switch activation signalling (for both switches)

After the correct password is entered, the switch is activated and you can hear the confirmation signal on your telephone. You can now speak (e.g. say: "The door is open") or listen (to the door-opening sound, etc.) until the switch is deactivated. Upon deactivation, you can hear the storing signal (see the Signals Overview).

## Call extension

2N<sup>®</sup> Analog Vario beeps 10 seconds before the call end to extend the call by 30 seconds press  on your telephone (DTMF). You can use this function repeatedly. The visitor, however, cannot use this function!



## Programming

The access to this mode is password-protected. For details refer to the Programming section. The voice menu considerably helps with programming 2N<sup>®</sup> Analog Vario. Having entered the programming mode, you can also alter any parameter and memory settings.



### Caution

- The above mentioned functions (except for calls to 2N<sup>®</sup> Analog Vario) require a **tone-dialling** telephone set.



## Signals Overview

Signal	Name	Meaning
	Confirmation	Sent immediately after line seizure for incoming calls (can be heard by the calling party); Signals switch activation (by DTMF) – can be heard by the person "at the other end" who activated the switch
	Refusal	Signals that a non-programmed button has been pressed; Signals that an incorrect password has been entered on the keypad; Can be heard from the loudspeaker after line connection (first connection signalling); Signals an incoming call if 2N <sup>®</sup> Analog Vario has not been programmed; When a disabled function has been entered from the keypad.



Signal	Name	Meaning
	Storing	Signals switch deactivation (if activated by DTMF).
	Hang-up	Sent to notify that the call is terminated (in all cases).
Long continuous tone		Signals that the unit is going through full initialisation or dialling memory or password clearing; Heard from the loudspeaker while the switch is activated by keypad.
"Attention, your call is being terminated"		Signals that the preset maximum call time will elapse within 10 seconds during outgoing and incoming calls
"Wait, please"		Optional message during call establishing
"Communicator number .....is calling"		Optional message for communicator identification
Voice menu		In the programming mode.

## Call Termination Options - Summary

1. The busy or continuous tone \*) after the call end.
2. The ringing tone \*) after a predefined count of rings.
3. The subscriber 'at the other end' pressed  .
4. The preset maximum call duration has elapsed.
5. 30 seconds after the switch use has elapsed.
6. A 2N<sup>®</sup> Analog Vario button was pressed during the call.
7. The  keypad button was pressed during the call (can be disabled).

\*) The communicator is able to detect a permanent tone, busy tone and ringing tone even if the tone has two frequency components as in the UK, the U.S.A. (the so-called BTT tone) and in Canada. This new function does not require setting of any parameter. One of the tone components must be of 440 Hz.

## Code Lock

The electronic lock connected to **2N<sup>®</sup> Analog Vario** can not only be activated by the phone but also directly from the door using the keypad. In this mode, the keypad behaves like a standard code lock with the following features:





- Both switches can be controlled (if 2 connected)
- Password length - 1 to 16 digits;
- Up to 10 passwords per switch;
- Switch activation time - 1 to 9 seconds;
- Acoustic switch activation signalling - continuous tone.

The code lock uses the same passwords as the ones that have been defined for the telephone based switch control. Remember that the default passwords (00 for switch 1 and 11 for switch 2) cannot be entered from the numerical keypad because they are notoriously known.

## Control

Enter the correct password and . If the password is valid, a long tone is transmitted for a predefined time (5seconds by default). The corresponding switch is activated during this time. If the password is invalid, **2N<sup>®</sup> Analog Vario** sends a refusal signal.

## Traditional Button Telephone

Any number can be "dialed" in this mode. To dial, press , and to hang up use . These keys are typically provided with pictograms  and . PSTN calls can be barred for a line in the PBX. The dialling type (tone, pulse) is selected in the programming mode. With pulse dialling, the  character initiates (upon off-hook) transition to tone dialling - like on any other telephone.

### Note

- If this function is enabled, you can press  to hang up an outgoing call initiated by pressing a separate button.

## DTMF Transmission during Outgoing Call

This function enables the unit to transmit DTMF tones when the connection with one of the pre-programmed numbers has been established. It is used in combination with automatic information systems, voice mailboxes, etc., which ask the calling party to select a service using tone dialling. This function, however, does not allow you to call destinations other than the pre-programmed ones.









## Buttons Substitution





This function is an analogy to memories in comfortable telephone sets. After two digits ranging between 01 and 54 (0 may not be omitted) are pressed, the call to the pre-programmed number is made. You can use **2N<sup>®</sup> Analog Vario** as if it had up to 54 separate buttons, which saves buying the extender units and space on the installations wall. The ideal solution is to use a few standard buttons for the most important speed dialling options e.g. Warden, Reception and then provide a list of pre-programmed options via the optional info panel that can be purchased.

### Admissible Keypad Function Combinations

All of the above mentioned 4 functions can be combined freely - each of them can be enabled or disabled separately as desired.

## Keypad Operation Instructions – Summary

- Door opening – code lock
  - Enter any valid password for switch 1 and  .
  - **Warning!** Password 00 may not be used!
- Switch 2 activation:
  - Enter any valid password for switch 2 and  .
  - **Warning!** Password 11 may not be used!
- Traditional button telephone
  -  gets **2N<sup>®</sup> Analog Vario** ready to dial a number.
  - ... Dials a number.
  -  Transmits into tone dialling during pulse dialling.
  -  Transmits a character in tone dialling.
  -  Hangs up anytime during a call.

- **DTMF transmission during outgoing call** (of a single button, not in the telephone mode!)
  - ... - tone-dials a number.
  -  - The character is sent normally.
  -  - The character is sent normally.
- **Buttons substitution:**
  - 01...54 - the number that complies with the selected button (memory) is dialled after a timeout.
  -  - If an asterisk is pressed after number 01...54, the number is dialled immediately unless it is identical with the set password.

## Frequently Asked Questions About Keypad Function

- *Can any of the switches be activated permanently?*

Yes, the additional switch can be activated by one password and deactivated by another.

- *Is it possible to arrange for the switch to be activated during the whole call?*

Yes, additional switch can do it.

- *Is it possible to use a single command to activate one switch first and the other later?*

Yes, it is possible to use parameter 824, Switch 2 delay.

- *Can both the switches be activated at the same time?*

While one switch is activated, the other can be activated by another password. You can also use parameter 824, Switch 2 delay, defining the shortest delay time possible (1second) and a sufficiently long switch activation time.

- *Can I use the code lock while another person is speaking through 2N<sup>®</sup> Analog Vario?*

Yes but this is not advisable as you should be aware that the password is private and could contravene security.

- *What happens when I press a number with no pre-programmed memory while the button replacing function is enabled?*

The same as if you pressed a button that is not pre-programmed: 2N<sup>®</sup> Analog Vario seizes the line, beeps refusal (refer to Signalling) and hangs up immediately.

- *What happens if a password is identical with the memory number while the code lock and button substituting functions are enabled?*



The code lock function has the highest priority. If, for example, the password is 33 and you press **33\***, the switch is activated instantaneously. If you press **33** without an asterisk, the line is seized after a preset delay and the number from memory 33 is dialled.

 **Tip**

- Keyboard letters facilitate password remembering. For example, it is easier to remember a 9-letter word (e.g. crocodile) than a 9-digit number (276263453).
- It is not recommended to use such passwords as 3333. This leads to a considerable wear and tear of one button and an unauthorised person may guess your password easily. It is ideal to employ all keys evenly, using several codes for different persons or groups.

## 2N® Analog Vario Statuses and Available Operations

Operation	Hang-up	Outgoing call	Incoming call	Programming	Telephone mode
Button pressing - new call	Y	x	—	—	Y
Call extension - DTMF <b>*</b>	—	Y	Y	—	Y
Call termination - DTMF <b>*</b>	—	Y	Y	Y	Y
Hang-up upon continuous, busy or ringing tone	—	Y	Y	Y	Y
Switch activation - DTMF password	—	x	x	—	x
Programming start	—	—	Y	—	—

Operation		Hang-up	Outgoing call	Incoming call	Programming	Telephone mode
Keypad	Switch activation - code lock	×	× 1)	—	—	—
	DTMF into outgoing call	—	×	—	—	Y 2)
	Button replacing (speed dial from memory)	×	×1)	—	—	—
	Off-hook by key  (into telephone mode)	×	—	—	—	—
	Hang-up by key 	—	Y1)	—	—	Y
	Hang-up by key 	—	Y1)	—	—	—

#### Explanatory notes:

- Y... Yes, always
- × ... Yes if this function is programmed
- 1) This holds if DTMF is disabled during outgoing calls (the corresponding tone is transmitted in that case).
- 2) If pulse dialling is selected, it is possible to switch into tone dialling by pressing  (but not vice versa!).

---

## 3.4 Section for Advanced Users

---

### Automatic Multiple Number Dialling

When you press a 2N<sup>®</sup> Analog Vario button, you may find out that the called line is busy or the called party is absent. 2N<sup>®</sup> Analog Vario is able to identify these situations and solve them by Automatic Multiple Number Dialling if one of three automatic dialling modes is enabled. Up to 6 numbers can be stored for each button.

The three automatic modes (see below) recognise the continuous, busy and ringing tones. In all of these modes, automatic dialling can be disabled or the required count of cycles can be preset (1 to 9; if none of the stored numbers is answered, the whole cycle is repeated starting with the first number again) for each button separately.

You can program Automatic Multiple Number Dialling for selected buttons only, retaining the others in the default mode, the selection of one of three automatic dialling modes is common.

### Automatic Multiple Number Dialling without Confirmation

This mode can be used in common cases to enable the visitor to get through even if the called line is busy or the called subscriber is absent. Hence, the second memory of the button may include the secretary's number, the third memory the porter's lodge number, etc.

This mode recognises the ringing tone and if the tone ends before the predefined count of rings, 2N<sup>®</sup> Analog Vario regards this as a successful connection, this solution is not fully reliable because detection may be hindered by noise, etc. No message is played back in this mode.

## Evaluation of Situations in Audible Automatic Dialling without Confirmation

Situation	2N <sup>®</sup> Analog Vario Action
Busy tone	Hangs up in approximately 2 seconds and dials the next number.
Call or silence without previous ringing tone	Waits for the preset timeout (log-in time), then hangs up and dials the next number.
Continuous tone (at the PBX, e.g.)	Hangs up in approximately 2 seconds and dials the next number.
Ringing tone, which is terminated before 10 rings are made (the count of rings is variable)	Regarded as a successful call, continues for the maximum timeout (maximum call duration). For details refer to the text under the table.
Ringing tone, 10 rings are made (the count of rings is variable)	Hangs up and dials the next number.
1 to 9, 0	These digits are interpreted as password beginning.
*	Call extension or password beginning.
#	Hang-up command.

If the ringing tone stops before the predefined count of rings is achieved and the call is thus very short (e.g. 2 seconds), it is not clear whether the call should be regarded as successful. Therefore, a new type of automatic dialling has been added – type 4.

The difference is as follows:

- Type 3 regards such a call as successful only if the door is opened.
- Type 4 regards all such calls as successful.



## Automatic Multiple Number Dialling with Confirmation

This mode is used where maximum connection reliability is required – for emergency calls. The called line (the supervisory control centre, e.g.) must be operated by a well-trained person to confirm connection. The DTMF is used as the most reliable criteria for successful connection. The called line must press **1** on its telephone. If the called number is busy or remains unanswered until the preset timeout or in other cases (see the table), 2N<sup>®</sup> Analog Vario dials the next number in the sequence.

## Evaluation of Situations in Audible Automatic Dialling with Confirmation

Situation	2N <sup>®</sup> Analog Vario Action
Busy tone	Hangs up in approximately 2 seconds and dials the next number.
Call or silence	Waits for the preset timeout (log-in time), then hangs up and dials the next number.
Ringing tone	Waits for the preset count of rings, then hangs up and dials the next number.
Continuous tone (at the PBX, e.g.)	Hangs up in approximately 2 seconds and dials the next number.
DTMF char <b>5</b> or <b>#</b>	Immediately hangs up and dials the next number.
DTMF char <b>1</b>	Confirms reception (2 beeps) and the call continue for the preset time at most (maximum call duration).
<b>1 2 3 4 5</b>	These digits are interpreted as control characters – refer to the DTMF Control subsection.

### **Note**

- It is sometimes difficult to recognise the above-described situations reliably due to a poor quality of the PSTN connection. Excessive noise in the surroundings may also have a negative impact. However, this may only decelerate automatic dialling (the busy tone may not be recognised, e.g.). Even if **2N<sup>®</sup> Analog Vario** cannot identify the DTMF, the connection is established (yet for a shorter time).

## **Silent Automatic Multiple Number Dialling**

This mode fully conceals the fact that a telephone call is made. When a button is pressed, the loudspeaker is off and no PBX or dialling tone can be heard. The loudspeaker is switched on when the called subscriber confirms connection (by pressing  on its telephone). Thus, a potential thief cannot establish whether the called person is in the building or not.

Otherwise, the function is the same as with Automatic Multiple Number Dialling with Confirmation.

## **2N<sup>®</sup> Analog Vario Identification**

There are situations in which the calling person does not want to or cannot speak for security reasons in the automatic dialling mode. In these cases, **2N<sup>®</sup> Analog Vario** can play back a message stored in its memory. The test series includes the "Wait please, connection is being established" message. Later, more messages will be available to the user.

## DTMF Control

If Automatic Multiple Number Dialling with Confirmation or Silent Automatic Multiple Number Dialling is enabled, 2N<sup>®</sup> Analog Vario can be controlled as shown in the table below. For convenience, commands 1 to 5 are arranged as they are usually used.

DTMF Character	Function
1	<b>Confirmation</b> indicating to 2N <sup>®</sup> Analog Vario that a call was successful. 2N <sup>®</sup> Analog Vario sends its confirmation signal, the call goes on until the end of timeout and any of the following commands can be used.
2	Message <b>muting</b> (during playback).  <b>Warning!</b> You may not speak while 2N <sup>®</sup> Analog Vario is playing back the message !!!
3	Message <b>re-plays</b> (once).
4 or * or	<b>Call extension:</b> a call is extended by 30 seconds by this command. Can be used repeatedly.
5 or # or	Call <b>termination</b> .
6 to 9, 0	These digits are interpreted as a password beginning - for switch control.

### Notes

- These commands do not work in the Automatic Multiple Number Dialling mode without Confirmation!
- The above-mentioned commands **may not be accepted** due to poor connection if sent during a message. To avoid this, press the button during the time of silence (between messages).

## Survey of Messages

The table below includes a survey of language versions for standard announcements. English is selected by default. To select another language, use parameters 976 and 977.

Value of parameter 976	Language selection - English version	End of call message	Outgoing call message	
			ID message. Parameter 975 must contain digit 2, 3 or 5	Confirmation message. Parameter 975last digit = 5
0	Tone signal	♪♪	off	off
1 (defaultvalue)	English	Attention, your call is being terminated.	Communicator number..... is calling .	Connection confirmed.
2	German	Achtung, das Gespräch wird beendet.	Es ruft das Notruftelefon Nummer.....an.	♪♪
3	Portuguese	.....	.....	♪♪
4	Dutch	.....	.....	♪♪

Value of parameter 977	Language selection – English version	Outgoing call message	Note
0	Tone signal	off	<ul style="list-style-type: none"> <li>To play this message, parameter 975 must start with digit 5.</li> <li>Parameter 977 has a range 0-99. On customer's request, additional messages can be added; e.g. other languages or more alternative messages in one and the same language.</li> </ul>
1*)	English	Wait please.	
2	German	Warten Sie bitte.	
3	Portuguese	.....	
4	Dutch	.....	

## Arrival/Departure, Day/Night Modes

2N<sup>®</sup> Analog Vario can identify easily where to 'route' (switch) a call after a button is pressed. All you have to do is call 2N<sup>®</sup> Analog Vario and enter the following:

- I'm leaving: \* password \* 1 \*
- I'm back: \* password \* 0 \*

All buttons can be switched all at once by a common **Day/Night password** or individually by separate **Departure/Arrival passwords**.







## How does switching work?

- Every button has memories for 6 numbers (intended primarily for Automatic Multiple Number Dialling).
- If the Automatic Multiple Number Dialling mode is **OFF**, memory 1 is used for the Day mode and memory 3 for the Night mode. This is a simple two-number switching.
- If the Automatic Multiple Number Dialling mode is **ON**, memories 1, 2, 3, 4, 5, 6 are used for the Day mode and memories 3, 4, 5, 6 are used for the Night mode in the above-mentioned order. This accelerates the process; numbers that would not be answered are skipped over.
- If the Night mode is on and memories 3 to 6 are empty, memories 1 and 2 are used.

- If the **Night** mode is on, memories 1 and 2 are omitted for **all** buttons and this cannot be disabled individually using the Arrival function.
- In the Day mode, the buttons assigned to persons who used the Departure function (are on a leave) shall remain in the Night mode until the same persons use the Arrival function (after the leave, e.g.).



### Example 1 – administration building, automatic dialling is off:

Button 01: labelled Mr. Smith, memory 1 = Mr. Smith's line, memory 3 – secretary's line, password for button 01 is 777.

1. *Mr. Smith is leaving for holiday. He calls 2N<sup>®</sup> Analog Vario and enters:*  777  
 1 
2. *A visitor comes, presses Mr. Smith's button – 2N<sup>®</sup> Analog Vario calls the secretary.*
3. *Mr. Smith comes back. He calls 2N<sup>®</sup> Analog Vario and enters:*  777  0  .

### Example 2 – family house, Silent Automatic Multiple Number Dialling:

Button 01: labelled The Johnsons, memory 1 = living room, 2 = workshop, 3 = Mr. Johnson's mobile telephone, 4 = Mrs. Johnson's mobile telephone. Arrival/Departure password for button 01 is 333.

1. *The family is leaving for holiday. They call 2N<sup>®</sup> Analog Vario and enter:*  333  
 1 
2. *A visitor presses the Johnson's' button – 2N<sup>®</sup> Analog Vario calls Mr. Johnson's mobile phone and, if unsuccessful, Mrs. Johnson's mobile phone.*

## 3.5 Maintenance

---

### Cleaning

If used frequently, 2N<sup>®</sup> **Analog Vario**, especially the keypad, gets dirty. To clean it, use a piece of soft cloth moistened with clean water. We recommend you to obey the following principles while cleaning:

- Never use aggressive detergents (such as abrasives or strong disinfectants);
- Clean the device in dry weather in order to make waste water evaporate quickly.

### Label Replacement, Programming Status Changes

For necessary steps refer to the preceding subsections. Keep the following for later changes:

- this manual;
- the completed programming form (including a copy);
- unused transparent foil strips for button labels.

#### **Caution**

- Always use the product for the purpose it was designed and manufactured for, in compliance herewith.
- The manufacturer reserves the right to modify the product in order to improve its qualities.
- 2N<sup>®</sup> **Analog Vario** contains no environmentally harmful components.  
When the product's service life is exhausted and you would like to dispose of it please do so in accordance with applicable legal regulations.

## 3.6 Downloads

---

Templates

Nametags



## 4. Technical Parameters

### Telephone Parameters

Parameter	Value	Conditions
Minimum required off-hook line current	15 mA	Off-hook
Minimum required on-hook line voltage	20 V	Hang-up
DC voltage drop (off-hook)	$< 8 \text{ V} < 16 \text{ V}$	I = 25 mA I = 50 mA
Lead current while hang-up	$< 25 \mu\text{A}$	U = 60 V
Off-hook AC impedance	220 $\Omega$ + 820 $\Omega$ 115 nF parallel	20 to 60 mA
Return loss	$> 10 \text{ dB}$	20 to 60 mA
Bandwidth	300 to 3500 Hz	20 to 60 mA
Ring impedance	$> 2 \text{ k}\Omega C = 1 \mu\text{F}$	25 to 50 Hz
Ring detector sensitivity	10 to 20 V	25 to 50 Hz
Time of response to ringing	Variable	
Pulse dialling	40/60 ms	20 to 60 mA
DTMF level	-6 and -8 dB $\pm 2 \text{ dB}$	20 to 60 mA
DTMF detector sensitivity	Min. -40 dB	20 to 60 mA

Parameter	Value	Conditions
Dial tone detector sensitivity	Min. -40 dB	350 to 500 Hz
Busy tone detection speed	Variable	350 to 500 Hz
Continuous tone detection speed	Variable	350 to 500 Hz
Ringing tone detection speed	Variable	350 to 500 Hz
Overvoltage protection - common mode	1000 V	8/20 $\mu$ s
Overvoltage protection - between A, B conductors	1000 V	8/20 $\mu$ s

### Other Parameters

- **Switch - max. voltage:** 48 V AC, DC
- **Switch - min. voltage:** 9 V AC, DC
- **Switch - max. current:** 2 A AC, DC
- **Backlight - rated voltage:** 12 V
- **Backlight - max. voltage:** 14 V
- **Backlight - current consumption:** Up to 1 A
- **Working temperature:** -20 °C to +60 °C
- **Coverage:** IP 53
- **Dimensions (1 module):** (210 × 100 × 29) mm
- **Weight:** up to 500g

## 4.1 Obecné výkresy

### Surface mounting

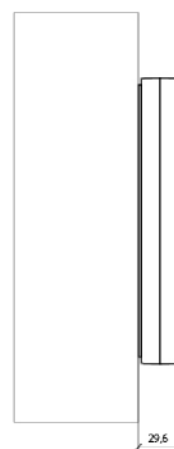
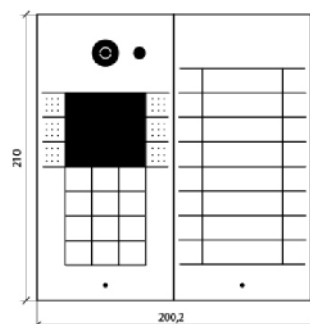
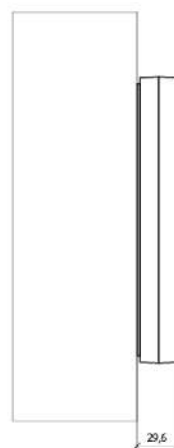
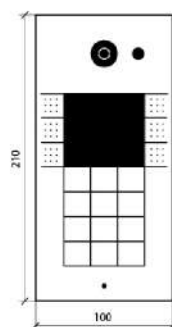

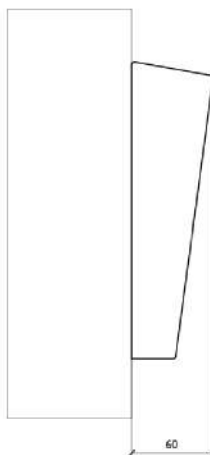
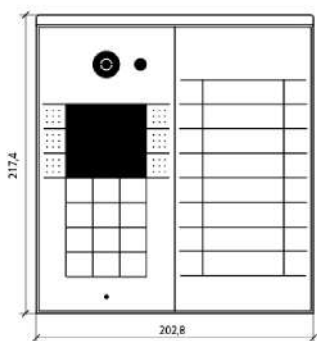
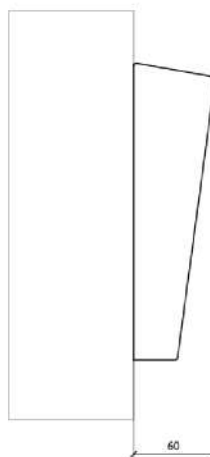
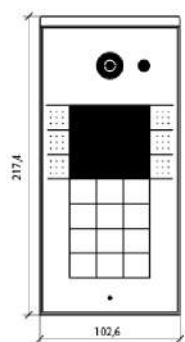

## Flush mounting

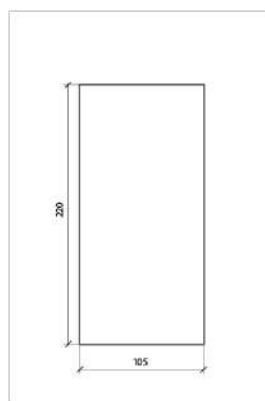
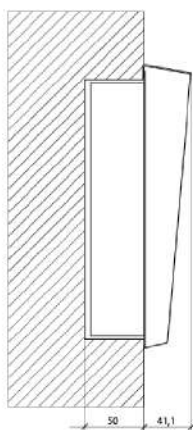
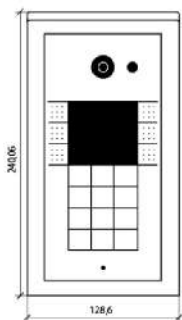

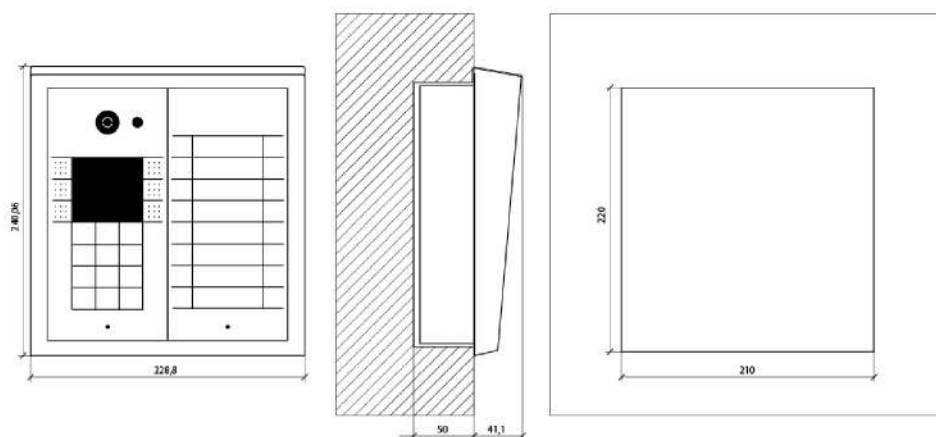

## 5. Supplementary Information

---

This section provides supplementary information of the product. Here is what you can find in this section:

- **5.1 Troubleshooting**
- **5.2 Directives, Laws and Regulations**
- **5.3 General Instructions and Cautions**

---

## 5.1 Troubleshooting

---



For the most frequently asked questions refer to [faq.2n.cz](http://faq.2n.cz).

## 5.2 Directives, Laws and Regulations

---

2N<sup>®</sup> Analog Vario conforms to the following directives and regulations:

- 2014/35/EU for electrical equipment designed for use within certain voltage limits
- 2014/30/EU for electromagnetic compatibility
- 2011/65/EU on the restriction of the use of certain hazardous substances in electrical and electronic equipment
- 2012/19/EU on waste electrical and electronic equipment



---

## 5.3 General Instructions and Cautions

---

Please read this User Manual carefully before using the product. Follow all instructions and recommendations included herein.

Any use of the product that is in contradiction with the instructions provided herein may result in malfunction, damage or destruction of the product.

The manufacturer shall not be liable and responsible for any damage incurred as a result of a use of the product other than that included herein, namely undue application and disobedience of the recommendations and warnings in contradiction herewith.

Any use or connection of the product other than those included herein shall be considered undue and the manufacturer shall not be liable for any consequences arisen as a result of such misconduct.

Moreover, the manufacturer shall not be liable for any damage or destruction of the product incurred as a result of misplacement, incompetent installation and/or undue operation and use of the product in contradiction herewith.

The manufacturer assumes no responsibility for any malfunction, damage or destruction of the product caused by incompetent replacement of parts or due to the use of reproduction parts or components.

The manufacturer shall not be liable and responsible for any loss or damage incurred as a result of a natural disaster or any other unfavourable natural condition.

The manufacturer shall not be held liable for any damage of the product arising during the shipping thereof.

The manufacturer shall not make any warrant with regard to data loss or damage.

The manufacturer shall not be liable and responsible for any direct or indirect damage incurred as a result of a use of the product in contradiction herewith or a failure of the product due to a use in contradiction herewith.

All applicable legal regulations concerning the product installation and use as well as provisions of technical standards on electric installations have to be obeyed. The manufacturer shall not be liable and responsible for damage or destruction of the product or damage incurred by the consumer in case the product is used and handled contrary to the said regulations and provisions.

The consumer shall, at its own expense, obtain software protection of the product. The manufacturer shall not be held liable and responsible for any damage incurred as a result of the use of deficient or substandard security software.

The consumer shall, without delay, change the access password for the product after installation. The manufacturer shall not be held liable or responsible for any damage incurred by the consumer in connection with the use of the original password.

The manufacturer also assumes no responsibility for additional costs incurred by the consumer as a result of making calls using a line with an increased tariff.

## **Electric Waste and Used Battery Pack Handling**



Do not place used electric devices and battery packs into municipal waste containers. An undue disposal thereof might impair the environment!

Deliver your expired electric appliances and battery packs removed from them to dedicated dumpsites or containers or give them back to the dealer or manufacturer for environmental-friendly disposal. The dealer or manufacturer shall take the product back free of charge and without requiring another purchase. Make sure that the devices to be disposed of are complete.

Do not throw battery packs into fire. Battery packs may not be taken into parts or short-circuited either.



An Axis company

**2N TELEKOMUNIKACE a.s.**

Modřanská 621, 143 01 Prague 4, Czech Republic

Phone: +420 261 301 500, Fax: +420 261 301 599

E-mail: [sales@2n.cz](mailto:sales@2n.cz)

Web: [www.2n.cz](http://www.2n.cz)

v1.5